

THIS DRAWING IS UNPUBLISHED. RELEASED FOR PUBLICATION
 © COPYRIGHT - BY TYCO ELECTRONICS CORPORATION. ALL RIGHTS RESERVED.

LOC	DIST	REVISIONS					
		P	LTR	DESCRIPTION	DATE	DWN	APVD
G	50		B1	REVISED PER ECR-06-011725	19MAY06	HMR	JR

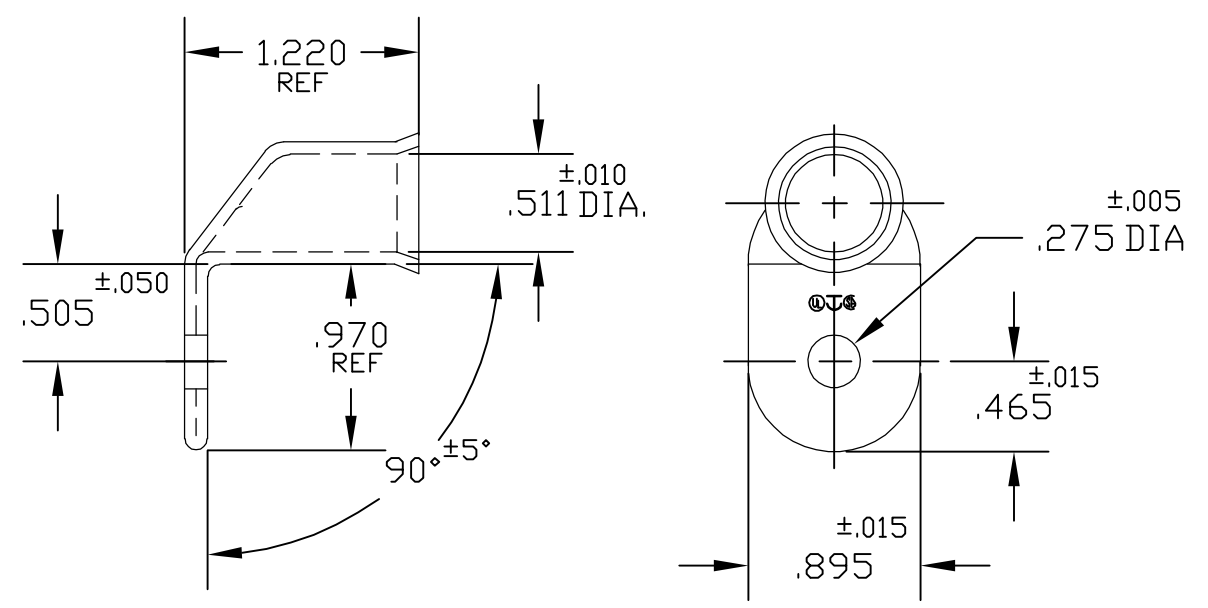

ACTIVE	30141-09-90	STANDARD	TIN PLATE	1526796-2
ACTIVE	30141-08-90	STANDARD	PLAIN	1526796-1
STATUS	AET P/N	PACKAGING	FINISH	PART NUMBER

THIS DRAWING IS A CONTROLLED DOCUMENT.		DWN D.A.A 11/1/00	Tyco Electronics Corporation Harrisburg, PA 17105-3608		
DIMENSIONS: INCHES		CHK H.D.F 11/1/00			
		APVD H.D.F 11/1/00	PRODUCT SPEC -		
TOLERANCES UNLESS OTHERWISE SPECIFIED: 0 PLC ± - 1 PLC ± - 2 PLC ± - 3 PLC ± - 4 PLC ± - ANGLES ± -		APPLICATION SPEC -	SIZE A3	CAGE CODE 00779	DRAWING NO C-1526796
MATERIAL COPPER ASTM B-152		FINISH -	WEIGHT -	RESTRICTED TO -	
CUSTOMER DRAWING			SCALE 1:1	SHEET 1 OF 1	REV B1